

# 15" Capacitive Touch PC i3-7100u

FT15I3CAPOB / 3030504568



- Intel® Core™ i3-7100U CPU
- 4GB RAM memory, 128GB Industrial SSD
- Supports Windows 10 & Linux (32Bit, 64Bit)
- Medical CE certified with EN60601-1-2:2015
- Anti-glare surface treatment (chemical etching)
- 10-Finger-Multi Touch Capacitive Touch Panel
- 1.1mm cover glass with 7H surface hardness
- Optically bonded Touch Panel to LCD Panel
- Patented IP65 front with silicon seal
- Integrated 2x2W waterproof speakers
- Integrated W-LAN
- 2 year guarantee

• *Optional: i3-7100U / i7-7600U Core CPU*

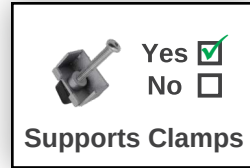

faytech's Capacitive PC series stands out among competition with its fanless silent operation, IP65 front panel design, high reliability and fine craftwork.

It is the perfect choice for industrial and business application. It has flat edge to edge glass with IP65 water- and dust proof front panels and a sturdy aluminum case with stable VESA 100 fixation bolts (VESA 400 for 32" and up).

The PC is powered by the high-end Kaby Lake U industrial mainboard. It has an Intel® Core™ i3-7100U processor with 4GB RAM, a 128GB SSD and Intel®'s HD graphics Chipset.

These faytech PCs are the perfect choice for a wide variety of applications including POS systems, control panels in industrial fields, in kiosk systems, office/residence automation, digital signage and in areas like shopping malls, classrooms, hotels and many more.



\*Above images without backcover fixed

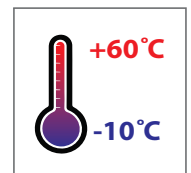

Product name	15" Capacitive Touch PC i3-7100U
Model number	FT15I3CAPOB / 3030504568

IP Rating	
IP65 Front / IP40 Back	

LCD Panel	
Screen diagonal (Inch/cm)	15/38.10
Display active screen size (cm)	30.40×22.80
Aspect ratio	4:3
Physical resolution	1024×768
External Maximum showable resolution - HDMI, DP	1920×1200
Colours displayed	16.7M
Brightness (cd/m <sup>2</sup> )	300
Contrast	700:1
Typical reaction time Tr / Tf (ms)	8/12
Visual Angle horizontal / vertical (°)	160/160
Backlight / Backlight Lifetime (hours)	LED / 30,000

Operation / Mechanical	
Operating Temperature (°C)	-10 ~ +60
Humidity Range (RH)	10% - 90%
Net weight (kg)	5.00
Gross weight (kg)	6.05 (incl. cartonage)
Housing material	Rubber front case, Aluminum IPC back case
Housing (mm) L × W × H	359.0 × 291.0 × 71.0
Cut-out for clamp supports (mm) L × H	335.0 × 274.0
Amount of clamps required	6
Mounting	VESA 100

Included in the Delivery
W-LAN antenna (RP-SMA female)
Short Installation Manual

Expansion Slots
1x mSATA full size (occupied by SSD)
1x M.2 E-Key Slot (occupied by Wifi card)
1x SATA connector
1x External PCIe x1 Straddle connector

PC System	
CPU	Intel® Core™ i3-7100U Processor Kaby Lake
Graphic GPU	Intel® HD Graphics
Audio	Realtek ALC3236 Audio CODEC
Memory	4GB DDR4
Storage (switchable)	faytech Industrial 128GB SSD
Network	2x Realtek PCIe GB LAN 8111G (1000Mbps) M.2 E-key Wi-Fi module
Driver Support	Win10; Linux; 32Bit/64Bit
Preinstalled OS	Linux Ubuntu 18.04.4 LTS

Touch Panel	
Touch Technology	Projected Capacitive 10-Point Multitouch
Touch Connector	USB
Touch Life (Contacts)	Unlimited
Surface Hardness	7H
Surface Treatment	Anti-glare (chemical etching)

Power	
Power Indicator	Green LED
Working Power (V)	9~36
Power Consumption (W)	Max. 32
Stand-By Consumption (W)	<1

External Connectors		
01. Power button		
02. COM3 (RS232/RS485 Switchable default setting RS485)		
03. COM4 (RS232/RS485 Switchable default setting RS485)		
04. GPIO	05. COM2 / RS232	
06. TOS Link S/PDIF	07. S/PDIF	
08. Ear-Out	09. Mic-In	
10. SSD slot / SIM-Cards slot	11. W-LAN antenna connector (screwable)	
12. 9~36V DC-In (screwable)	13. COM1 / RS232	
14. USB 3.0 / USB 3.0	15. USB 3.0 / USB 3.0	
16. 10/100/1000Mbit network interface	17. 10/100/1000Mbit network interface	
18. HDMI	19. DisplayPort	20. PCIe x1

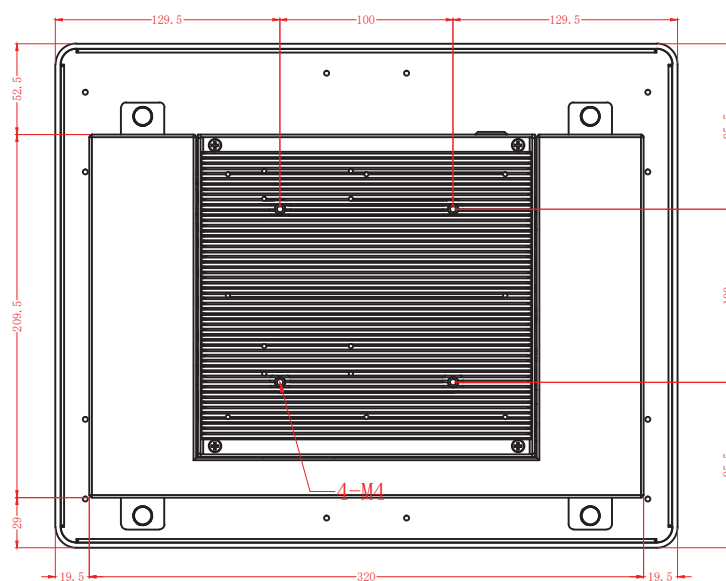
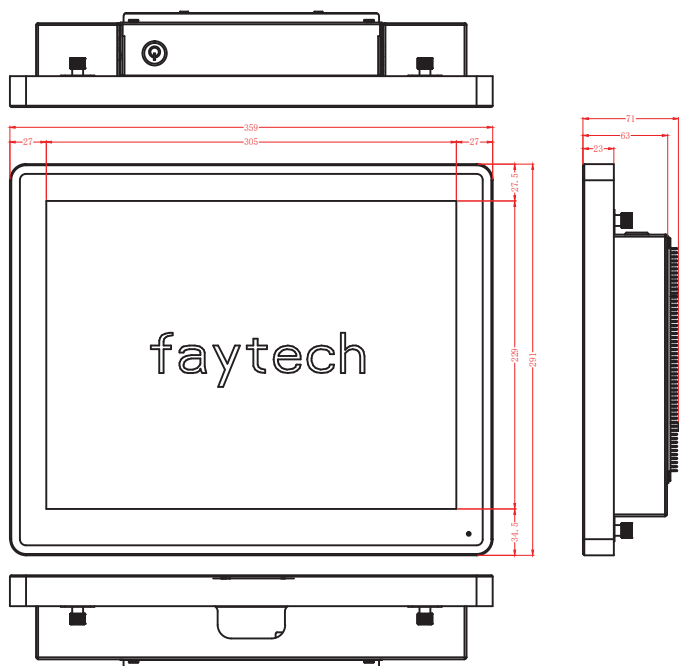

Tolerance: ± 1MM

# External Connectors

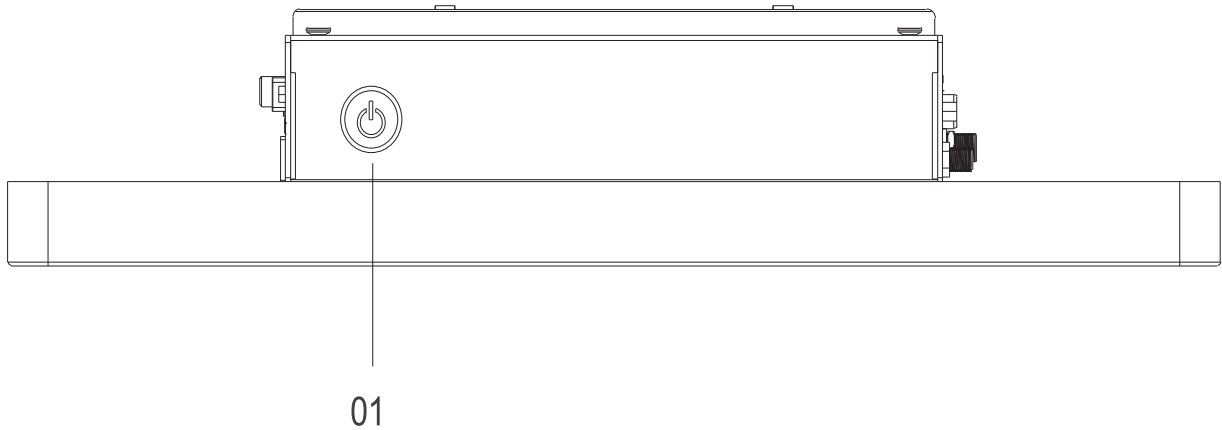
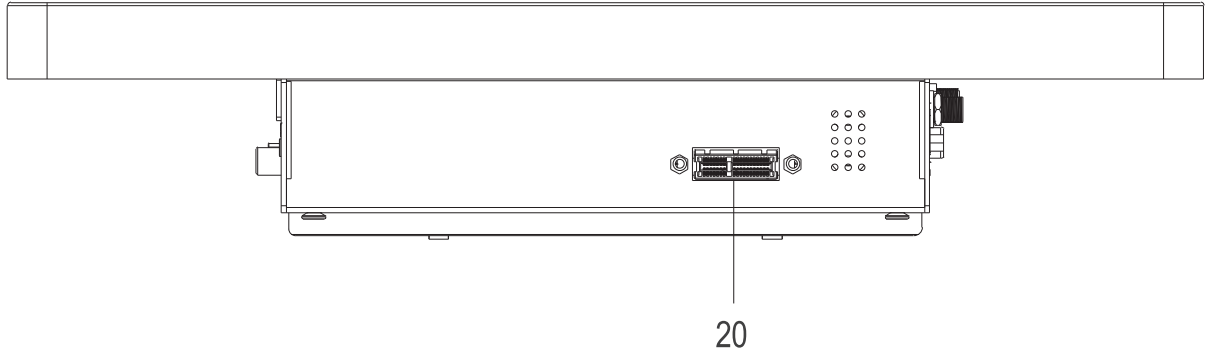
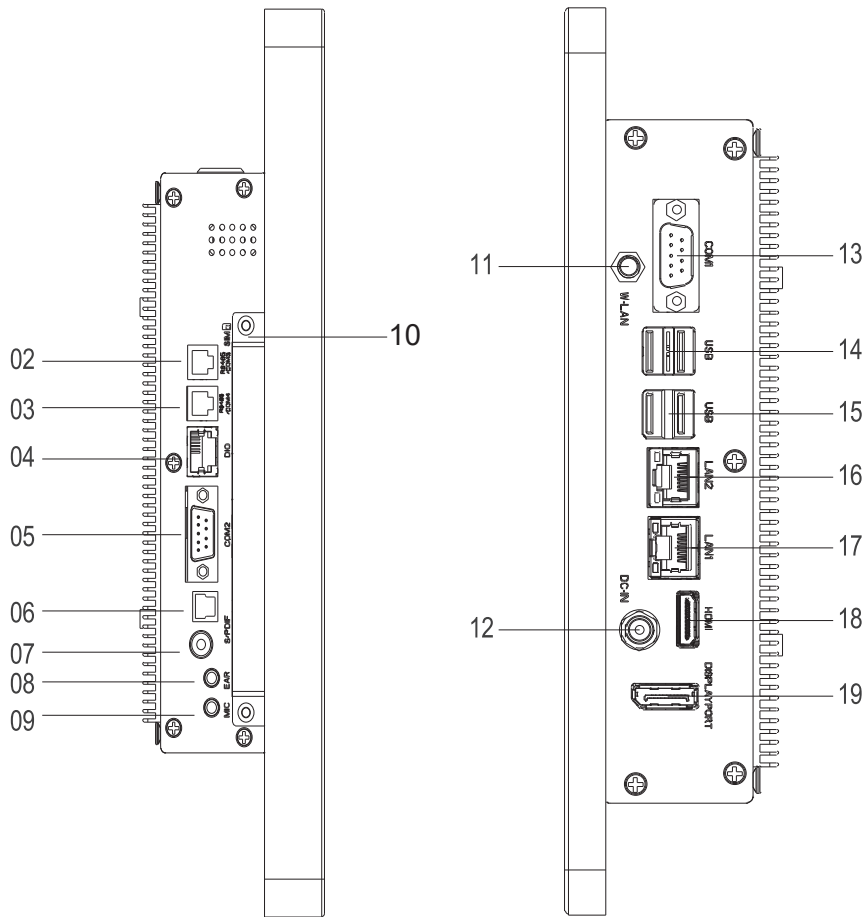

## Corporate Headquarters

**faytech AG**

Bischhäuser Aue 10  
37213 Witzenhausen  
Germany

[support@faytech.com](mailto:support@faytech.com)  
[contact@faytech.com](mailto:contact@faytech.com)  
[www.faytech.com](http://www.faytech.com)

China: +86 755 8958 0612  
Germany: +49 5542 30374 10  
USA: +1 646 205 3214  
India: +91 11 49707436  
Japan: +070 4127 5167